



KONICA MINOLTA

KEEP YOUR BUSINESS IN THE BLACK

RETHINK MONOCHROME
PRINT PRODUCTION



AccurioPress
7136/7136P/7120

Giving Shape to Ideas

ACCELERATE YOUR BUSINESS WITH AccurioPress SYSTEMS

To stay in the black, your business needs to stay productive.

The AccurioPress 7136 series is all you need for Smart Factory printing at speed. Optimise your print production planning and maximise the profitability of your mid-volume print environment with these next generation systems. Built on almost 20 years of expertise in print production the AccurioPress 7136 series knows what you need, integrating seamlessly with your workflow. Better still, it connects easily with your service and business platforms – whether they're on site or in the cloud.

Exceptional print quality every time

Its exclusive Intelligent Quality Optimizer IQ-501 leverages Konica Minolta's long history of brilliant imaging technology allowing you to wow your customers with stunningly consistent prints, time and time again.

Grow your business

Our mission is to empower you to grow your business with our solutions. The AccurioPress 7136/7136P/7120 is a great example, helping you with its extensive variety of supported media, from thin to thick paper (up to 350 gsm) including envelopes. What's more, our stock library provides a stack of media profiling capabilities to ensure you can always access the right setting for the best available output.

Intelligent Automation

The optional IQ-501 Intelligent Quality Optimizer ensures you get perfectly consistent colour quality and front-to-back registration on every print, in real-time. And because there are no recalibrations or inspections mid-run, you'll benefit from improved productivity too.

Boost your operational efficiency

Our new generation of true production systems has been designed to increase the uptime of your press and print, saving you time. Their range of new features lets you produce more higher-value print products more quickly. By pairing your AccurioPress 7136/7136P/7120 with one of more of our professional in-line finishers – such as booklet making, punching or binding – you can enhance your productivity to the maximum.

19

Allegro



30



8

pp 8

5 4 2 3 1 4 5 4 2 5 1 4

1 2 1 (3) 2 1 4 5 4 1 5 2 4 1 5

5 1 2 1 (3) 2 1 4 5 4 1 5 2 4 1 5

2 4 1 5 2 4 1 5 2 4 1 5



INNOVATE PRINT

RETHINK TECHNOLOGY

S.E.A.D. IMAGE PROCESSING

Konica Minolta's own advanced colour processing technology of the second generation is called S.E.A.D., which stands for "Screen-Enhancing Active Digital Process" and combines an array of technical innovations to guarantee truly exceptional colour reproduction at top speed. S.E.A.D. includes these important capabilities:

SIMITRI HD TONER

The extremely small size and uniform shape of ultra-fine Simitri® HD toner particles assure highest image quality as well as razor-sharp reproduction of text and line drawings. Simitri® HD unfailingly delivers consistently excellent image output quality on par with offset quality.

Simitri HD
High Definition Polymerised Toner

MEDIA DETECTION SENSOR

The optional media sensor IM-101 automatically detects the type, weight, thickness and surface of each substrate, and proposes the appropriate paper settings from the catalogue.

This makes wrong paper settings a thing of the past, avoiding misprints and waste.

INTELLIGENT QUALITY OPTIMIZER

An automatic mode enables even unskilled operators to make simple and straightforward adjustments to density and front to back registration in no time, facilitating the continuous production of prints with the highest quality.

INTELLIGENT
QUALITY CARE 

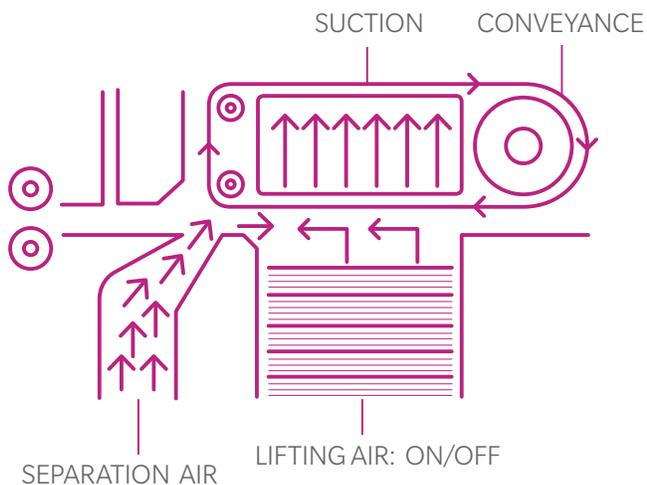
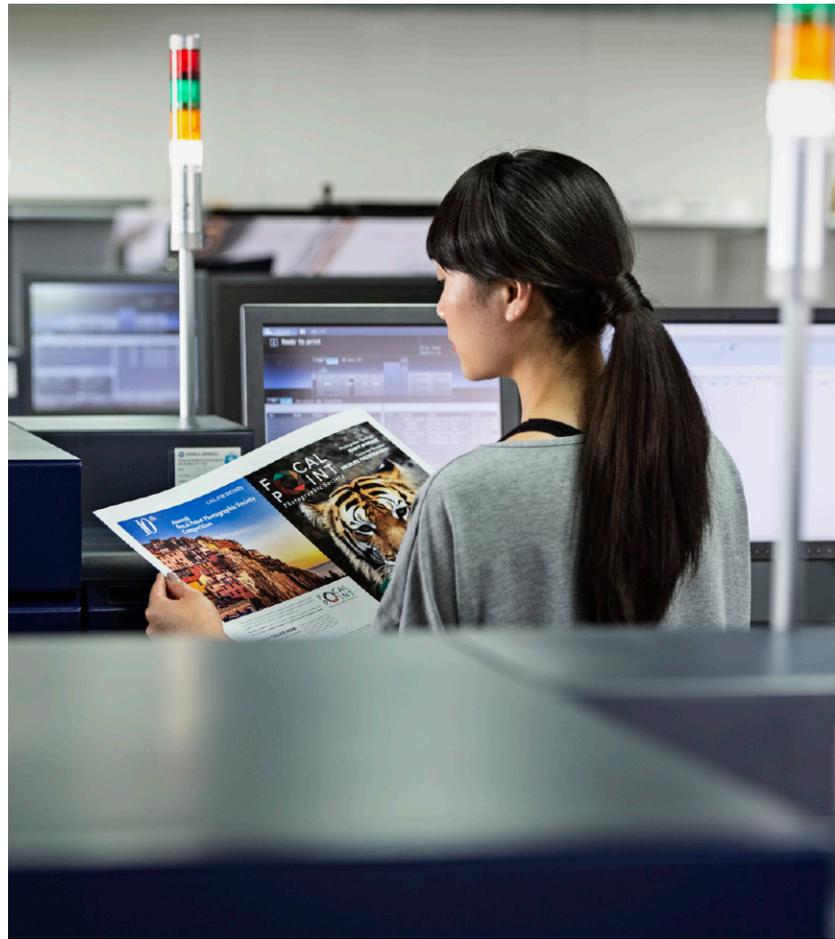

VACUUM PAPER FEEDING

For high-volume printers, feeding each and every sheet smoothly and precisely through the digital press is an essential requirement. To ensure this, Konica Minolta offers professional and intelligent paper feeding that builds upon proven concepts, including a combination of air separation of sheets and suction/vacuum feeding. This ensures smooth paper processing throughout the printing system. For efficient printing on offset preprinted and coated stock as well as under conditions of high humidity, an optional heating unit can be added to enhance this precise technology further.





POWERFUL PRINT SERVER

RETHINK YOUR USER EXPERIENCE

MIC-4160 FIERY CONTROLLER

Reduce labour costs, cut turnaround times, and minimise errors and paper waste with the advanced job management and workflow automation that the MIC-4160 provides. Streamline your job layout with the Fiery's instant visual preview and advanced ready-made capabilities. What's more, by supporting industry leading variable data printing (VDP) formats, the Fiery also produces personalised short-run jobs profitably.

IC-316m CREO CONTROLLER

The Creo® IC-316m external print controller offers unparalleled through performance and automation. Supports perfect variable data printing integration and is the ideal choice for hybrid prepress workflows. Beyond that, the Creo features Remote Site Manager status tracking, JDF connectivity, Creo job ticket software, and much more.

MIC-4170 FIERY CONTROLLER

Produce high value, complex applications with superior image quality to maximise your profitability. The top-of-the-line Fiery® MIC-4170 will improve your bottom line with best-in-class processing, outstanding quality and time-saving workflows. Automate job preparation steps in prepress workflows to produce ready-to-print files with Fiery JobFlow™ Base. This easy-to-use automation software increases productivity and reduces costs.

KONICA MINOLTA OWN CONTROLLER

The Konica Minolta controller comes with powerful workflow benefits printing at full rated engine speed, highspeed RIP processing, enhanced accuracy in colour reproduction, various colour management functions as well as full compatibility with print engine on-board job control and editing functions.

Functions and Features

Queue management

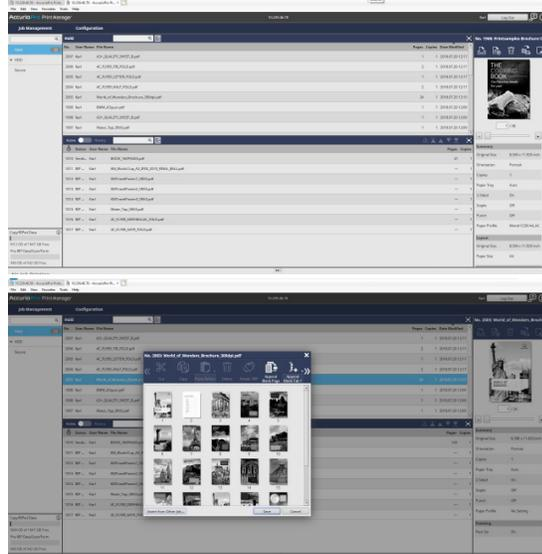

Page editing

Tone curve utility

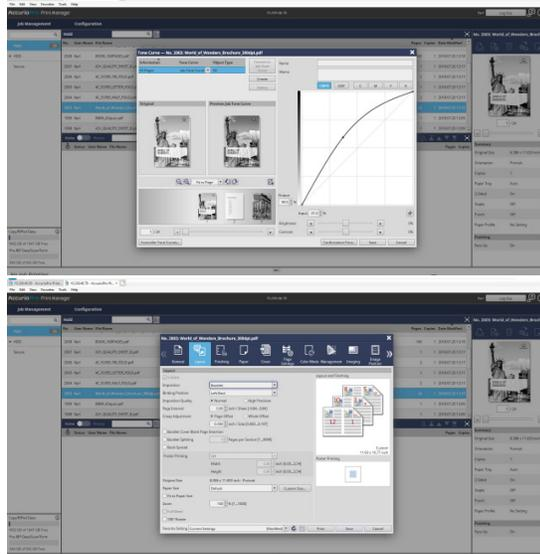

Job properties



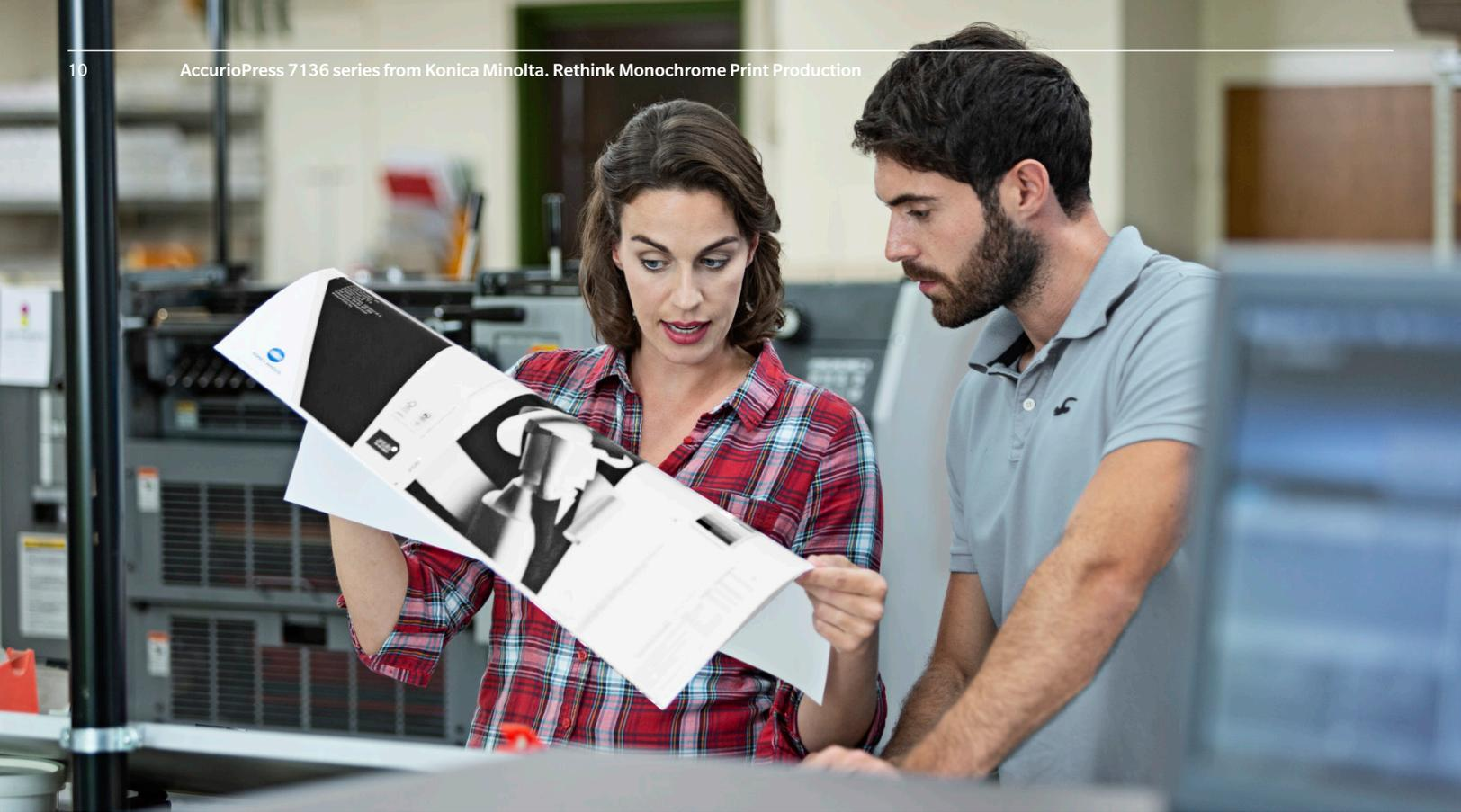

STREAMLINE YOUR PRODUCTION

RETHINK YOUR WORKFLOW

Evolving from our expertise in precision technologies and more than 80 years of experience in the printing and imaging industries, AccurioPro reflects our commitment to developing market-shaping technology with functionality that enables your business to grow. AccurioPro, Konica Minolta's suite of digital solutions for professional printing, is one of the industry's most versatile and powerful tools to optimise print production operations and workflows.

For all printing companies looking to integrate their printing as well as businesses that use digital printing

to produce their own in-house publications and promotional materials, AccurioPro boosts speed and efficiency, expands capabilities and services, and reduces the need for operational manpower – all of which will help improve your profitability!

The comprehensive suite of features that AccurioPro offers includes centralised management, software for automated workflow processing, colour management, seamless integration of different printing technologies and full connectivity of all Konica Minolta printing systems used from input to output.

AccurioPro POSSIBILITIES RETHINK YOUR WORKFLOW

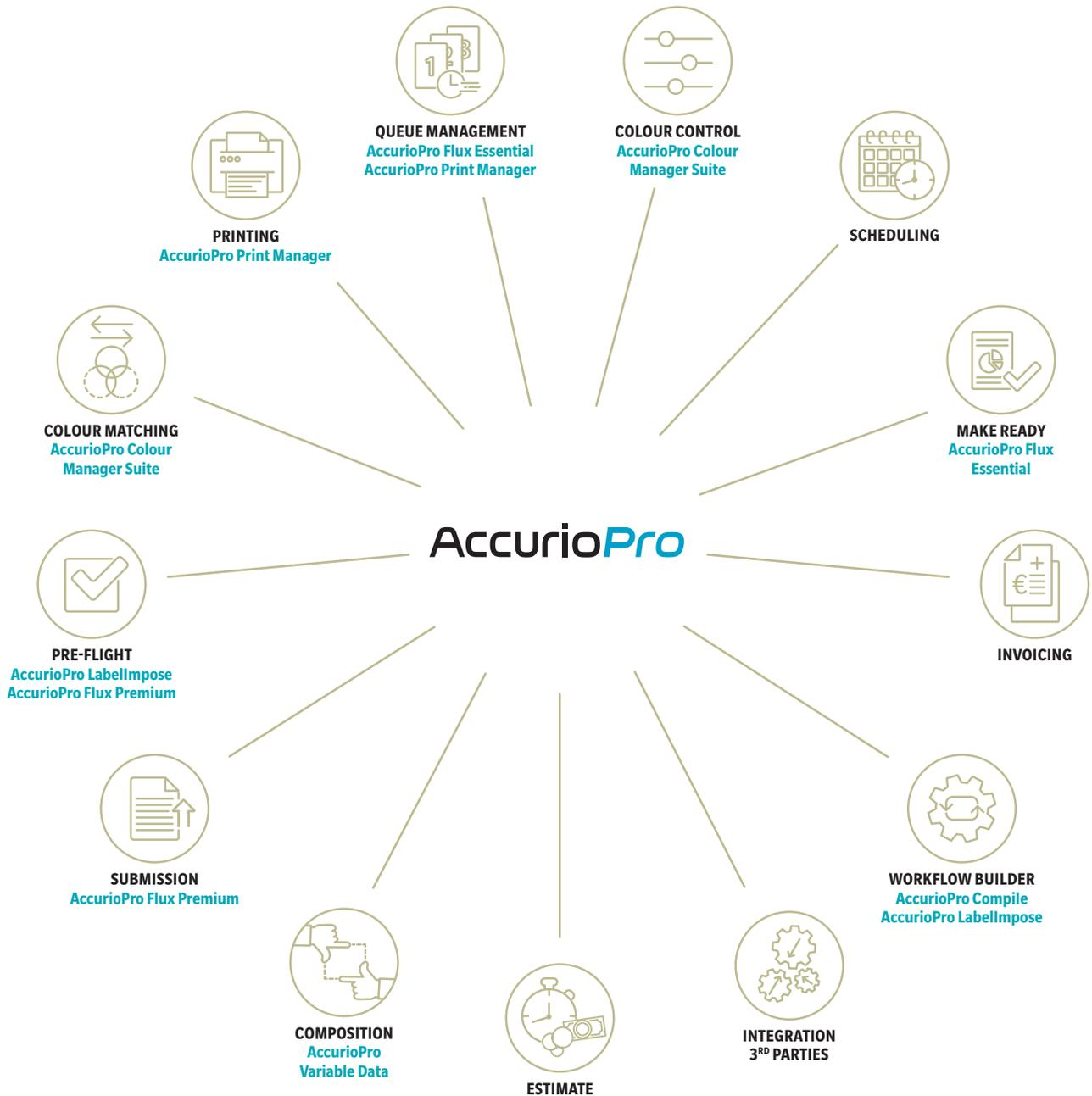

YOUR ADVANTAGES WITH THE AccurioPress 7136

RETHINK MONOCHROME PRINT PRODUCTION

READY-MADE PRINT PRODUCTS

- 50-sheet booklet making with front trimming and optional creasing, slitting and spine corner forming
- Perfect binding for books of up to 1.18"
- 100-sheet stapling with cutting mechanism
- Automated inline business card and postcard cutting
- Full bleed 11 x 17" and 8.5 x 11" posters

DURABLE PERFORMANCE

AccurioPress 7136/7136P

- Duty Cycle up to 3.24 million prints
- Up to 136 8.5 x 11" pages per minute

AccurioPress 7120

- Duty Cycle up to 2.5 million prints
- Up to 120 8.5 x 11" pages per minute

HIGHEST RELIABILITY

- Long-life platform, long-lasting parts and consumables
- Optimal registration results via ICCU
- Belt transfer system
- For prints with maximum efficiency
- For lucrative short-run printing

GEARED-UP FINISHING

- Multi (GBC) punching and 2- & 4-hole punching
- 6 different types of folding
- 3rd-party Products
- Large-capacity stacking
- 2 Perforations in feed direction, 5 Perforations in Cross feed direction
- Up to 5 Creases downwards or upwards

SIMPLY EFFICIENT

- Automated engine linearisation
- Automated duplex registration
- Automated profiling
- Real-time adjustments
- Purge function



HIGH-END PRINT CONTROL

- Flexible choice of controller technology: Fiery, Creo or Konica Minolta Controller
- Integration into hybrid workflows

EASE OF USE

- Auto Inspection Technology
- About 220 paper profiles loaded as standard
- Optional Intelligent Media Sensor IM-101 to detect type and weight of the paper
- Unified user interface among Konica Minolta engines

PERFECT IMAGE QUALITY

- 1,200 x 1,200 dpi print resolution
- Tone Curve Utility
- S.E.A.D. Technology
- Simitri HD Toner Technology

SOPHISTICATED MEDIA HANDLING

- Air suction feeding technology
- Up to 18,000 sheets paper feeding from 11 trays
- Pre-set paper catalog

COMPREHENSIVE MEDIA PROCESSING

- Paper weights from 40 – 350 gsm in simplex and up to 300 gsm in duplex printing
- Optional heating units to support preprinted paper
- Envelop printing as standard
- Optional inter-cooler and eliminator



FINISHING & FUNCTIONS

		 Letter fold	 2/4 hole Punching	 Two-point stapling	 Corner stapling	 Stacking	 Booklet	 Trimming
Open stacker OT-512								
Staple finisher FS-532/541								
Booklet making unit SD-513								
Stacking unit LS-507								
Folding and punching unit FD-503								
Perfect binding unit PB-503								
Booklet making unit SD-506								
Trimming unit TU-510								
Booklet making unit Plockmatic SD-435/450								
Booklet making unit PSQ-160								
Booklet making unit PSQ-224								
Ring binding unit GBC G1								
Multi punching unit GBC G3								

Creasing	Slitting	Perforation	Square-folding	Multi Letter fold-In	Post Insertion	Perfect Binding	Wire-binding	Ring-binding	Multi-punching	
					Optional					ENTRY
Standard	Standard		Standard	Standard						MID
				Standard	Standard					
					Standard	Standard				
Standard	Standard	Standard								
Standard	Standard		Standard							HIGH
	Standard		Standard							
	Standard		Standard							
							Standard			
Standard		Standard							Standard	





10 GOOD REASONS TO CHOOSE THE AccurioPress 7136 series



1. PERFECT IMAGE QUALITY

with Konica Minolta's own imaging technology and toner development.



2. OUTSTANDING PAPER COMPATIBILITY

for media from 40 to 350gsm. Excellent paper feeding options plus de-curling and paper cooling as standard.

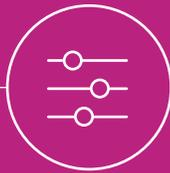

3. VERSATILE CONFIGURATIONS

with over 700 ways to set up your press.



4. BENEFIT FROM GREAT BUILT-IN TECHNOLOGIES

such as the latest screening and registration.



5. SHORT TURNAROUNDS

thanks to workflow automation options.



6. INCREASE UPTIME

with automated and time reduced set up times.



7. IMPROVE YOUR CUSTOMER LOYALTY

with auto quality measures to meet expectations.



8. MORE JOBS IN THE SHOP

with ready-made print products, geared-up finishing and a variety of in-line solutions.



9. AUTOMATED FINISHING

with many unique in-line options to create ready-to-ship booklets, perfectly bound books, ring or wire bound books and much more.



10. COMPLIANCE

with global environmental standards.

TAKE LEADERSHIP AND RESPONSIBILITY

RETHINK TOMORROWS BUSINESS

MADE FOR YOUR BUSINESS

Commercial printers

Growing your business and getting the maximum out of your investment is what the AccurioPress 7136 series promises. The high speed, high productivity and high uptime help you achieve shortest turnaround times. Combined with great media flexibility with stocks of up to 350 gsm, you further enhance the offerings of your print shop. Quality issues are a thing of the past, as these presses offer a wide range of tools to control and adjust themselves.

CRDs

AccurioPress 7136 series support a high degree of automation and yet also ensure high-level quality. Professional inline finishing produces ready-made print products at the click of a finger. Their versatile media flexibility and high productivity make AccurioPress 7136/7136P/7120 a solid and lucrative investment for the future.

DESIGNING FOR OUR PLANET

Konica Minolta promotes sustainable development and integrates environmental and social perspectives into its business strategies. You can rely on Konica Minolta products to underpin your green strategy to build your business.

Committed to help prevent global warming, Konica Minolta strives to reduce CO2 emissions during product manufacture, product distribution, at the sales stage, and during product use. Enabling carbon neutrality, Konica Minolta offers its customers the offset of unavoidable CO2 emissions for production printing. Together with the experts from Climate Partner, Konica Minolta proposes a new and profound eco concept for our professional production presses.

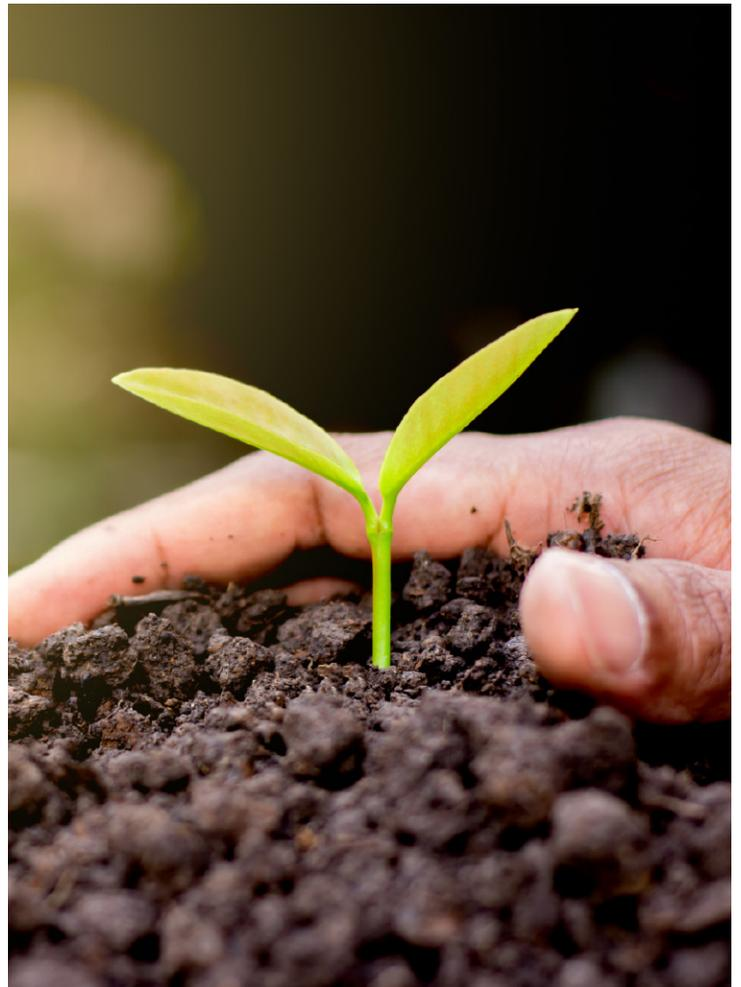



CONTROLLER AND OPTIONS

RETHINK THE NEEDS

KONICA MINOLTA CONTROLLER

Type	Built-in type
Resolution	Print: 1,200 x 1,200 dpi; 600 dpi x 600 dpi
CPU	Intel i5 6500 3.2 GHz
Memory	16 GB
HDD	2x 1TB
SSD	4 GB
Interface	Ethernet 10/100/1000BASE-T; USB 3.0 (for direct print, service) USB 2.0 (for local print)
Page-description language	PCL5E/XL (PCL6); Adobe PostScript 3 (PS3020); PDF directprint (PDF Ver.1.7); TIFF (TIFF Ver.6) direct print; PPML (Ver 2.2), APPE (Ver. 4.6, UK-217 required)

FIERY IMAGE CONTROLLER MIC-4160

Architecture	External
OS	Windows 10
CPU	Intel Pentium Gold G5400
Clock speed	3.7 GHz
RAM	8 GB (2x 4 GB)
HDD	500 GB, SSD boot driver for OS and Fiery software
Page-description language	Adobe PostScript 3; PDF v1.7; APPE v5.5; PDF/VT-1/-2 v3; PDF/X1a,3,4; PPML v3.0; PCL; Creo VPS; Applicable OS Windows 8.1/10; Windows Server 2012/R2/2016/2019; Mac OS X 10.11-14

FIERY IMAGE CONTROLLER MIC-4170

Architecture	External
OS	Windows 10
CPU	Intel i5-8500 processor
Clock speed	3.2 GHz
RAM	8GB (2x4GB)
HDD	1TB, SSD boot driver for OS and Fiery software
Page-description language	Adobe PostScript 3; PDF v1.7; APPE v5.5; PDF/VT-1/-2 v3; PDF/X1a,3,4; PPML v3.0; PCL; Creo VPS; Applicable OS Windows 8.1/10; Windows Server 2012/R2/2016/2019; Mac OS X 10.11-14

IC-316M CREO CONTROLLER

Architecture	External
OS	Windows 10
CPU	Intel i7-8700
Clock speed	3.7 GHz
RAM	8GB (2x4GB)
HDD	8 TB (2 TB system; 3x 2 TB image)
Page-description language	Adobe PostScript 3; PDF v1.7; APPE v4.9; PDF/VT-1/-2; PDF/X1a,3,4; PPML; Creo VPS; AFP; IPDS; JPEG; TIFF (v6, 1bit) Applicable OS Windows 8.1/10; Windows Server 2012/ R2/2016/2019; Mac OS X 10.11-15

OPTIONS

Air assist paper feed unit	PF-709
Pre-printed paper feed kit for PF-706	PP-701
Air-assist paper feed unit	PF-710
Heating unit for PF-710	HT-506
Post insertion unit	PI-PFU
Relay unit	RU-518m
Humidification unit	HM-103
Integrated Colour Care unit	IQ-501
Purge Unit	RU-702
Auto Inspection Unit	UK-301
Envelop Fusing Unit	EF-109
Intelligent Media Sensor	IM-101
Relay unit	RU-510
Folding and punching unit	FD-503
Stacking unit	LS-507
Booklet making unit	SD-506
Booklet making unit	SD-513
Creasing unit for SD-513	CR-101
Slitting unit for SD-513	TU-503
Spine corner forming unit for SD-513	FD-504
Perfect binding unit	PB-503
Stapling unit	FS-532m
Stapling unit	FS-541
Saddle stitch kit for FS-532m /FS-541	SD-510
Punch kit for FS-532m/FS-541	PK-525
Post inserter for FS-532m /FS-541	PI-502
Open stacker	OT-512
Trimmer Unit	TU-510
Creaser kit (Downwards)	CR-102
Creaser kit (Upwards)	CR-103
Trimmer kit	TU-504
Business Card Unit	JS-507
Perforation kit Horizontal	PE-101
Perforation kit Vertical	PE-102
Scrap ejection kit	MK-765
Mount kit for 3rd-party options	MK-737
GBC Punch	G3
GBC Wire Binder	G1
Plockmatic	PowerSquare™ 160
Plockmatic	PowerSquare™ 224
Plockmatic	SD-450/SD-435



CAUTION
OVERTOW SWITCH
STAY CLEAR

866-103
FR413R

STRAP INSTALLATION
YES NO

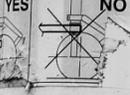

GOODFRIEND

EIGHT LEADER

NITROGEN INFLATION ONLY

TECHNICAL SPECIFICATIONS

RETHINK INNOVATION

SYSTEM SPECIFICATIONS

Resolution	1,200 x 1,200 dpi
Paper weight	40-350 gsm
Paper sizes	Min.: 3.74" x 5.24" (95 x 133 mm) * Max.: 12.76" x 19.02" (324 x 483 mm) *with PF-710
Paper input capacity	Max.: 18,000 sheets
Main unit dimensions (W x D x H)	39" x 35.8" x 57" (990 x 910 x 1,454 mm)
Main unit weight	813.5 lb (AccurioPress 7136/7120) 761 lb (AccurioPress 7136P)

- All specifications refer to 8.5 x 11" size paper of 80 gsm quality unless otherwise noted.
- The support and availability of the listed specifications and functionalities varies depending on operating systems, applications and network protocols as well as network and system configurations.
- Some of the product illustrations contain optional accessories.
- Specifications and accessories are based on the information available at the time of printing and are subject to change without notice.
- Konica Minolta does not warrant that any prices or specifications mentioned will be error-free.
- All brand and product names may be registered trademarks or trademarks of their respective holders and are hereby acknowledged.

PRODUCTIVITY

AccurioPress 7136/7136P

8.5 x 11" - max. per minute	136 ppm
11 x 17" - max. per minute	76 ppm
12 x 18" - max. per minute	74 ppm
8.5 x 11" - max. per hour	7,940 ppm
11 x 17" - max. per hour	4,526 pph
12 x 18" - max. per hour	4,274 pph

PRODUCTIVITY

AccurioPress 7120

8.5 x 11" - max. per minute	120 ppm
11 x 17" - max. per minute	78 ppm
12 x 18" - max. per minute	66 ppm
8.5 x 11" - max. per hour	7,034 pph
11 x 17" - max. per hour	4,072 pph
12 x 18" - max. per hour	3,846 pph

For more information about Konica Minolta products and solutions, please visit: www.konicaminolta.ca

© 2023 KONICA MINOLTA BUSINESS SOLUTIONS (CANADA) LTD. All rights reserved. Reproduction in whole or in part without written permission is prohibited. KONICA MINOLTA and the KONICA MINOLTA logo are registered trademarks or trademarks of KONICA MINOLTA, INC. All other product and brand names are trademarks or registered trademarks of their respective companies or organizations. All features and functions described here may not be available on some products. Design and specifications are subject to change without notice.



KONICA MINOLTA

KONICA MINOLTA BUSINESS SOLUTIONS (CANADA) LTD.

5875 Explorer Drive, Suite 100

Mississauga, Ontario, L4W 0E1

www.konicaminolta.ca



KMCA-AP7136-B-20-10-23-EN